



## ORTHOPAEDIC IMPLANTS & INSTRUMENTS



Please Visit Our WebSite  
[www.kiransurgicalsystems.com](http://www.kiransurgicalsystems.com)  
For Detail Specification & Further Information

# EXTERNAL FIXATOR SYSTEMS



Twisted & Curved Plates



External Fixator-Illizarov  
Full Ring SS

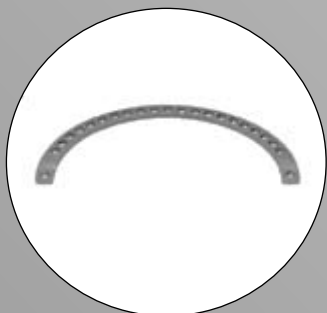

External Fixator-Illizarov  
1/2 Ring

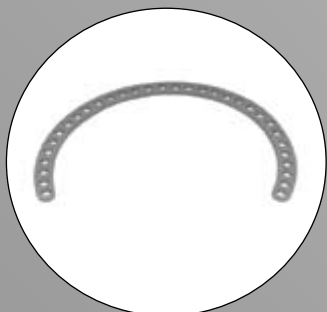

External Fixator-Illizarov  
5/8 Ring

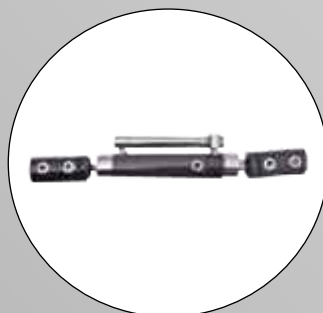

Dynamic Fixator



Ortho Fixator



Radius Fixator



Elbow Fixator



Rail Fixator

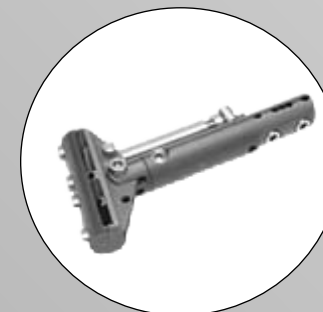

T-Type Fixator

## EXTERNAL FIXATOR SYSTEMS



**Small Single Pin Clamp**  
4 x 2.5mm



**Small Connecting Clamp**  
4 x 4mm



**Single Pin Clamp**



**Two Pin Clamp**



**Tube To Tube Clamp**



**Transverse Clamp**



**Connecting Clamp**



**Twin Adjustable Clamp**

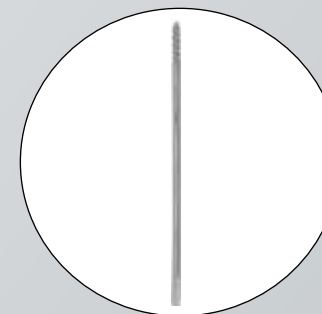

**Front Threaded Pin**  
(WITH DOUBLE TROCAR TIP)

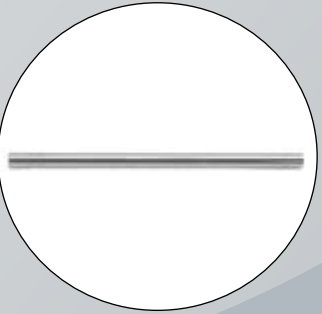

**Tubular Rod**  
11mm Dia

# DRILL & SAW SYSTEMS



## DRIVING UNIT

Stainless steel mobile folding stand Power Motor 90 Watt, 220 V/5 amp AC supply In built MCB (Miniature Circuit Breaker) Foot switch for speed control Flexible shaft with double ball bearings (Autoclavable)



## DRILLING HANDPIECE

(Autoclavable) Stainless Steel Drill Chuck (0 - 1/4) Cannulated 5.5 mm Specially scratch proof coated



## Flexible Shaft For Driving Unit



## UNIVERSAL DRIVER

(Autoclavable) Suitable for Reaming with Quick Coupling Cannulated 5.5 mm Speed 400 R.P.M. Stainless Steel Chuck Adopter (0 - 1/4) Specially scratch proof coated Adaptors available



## Saw Blades

Cutting Thickness 0.8 to 1.27 Usable Length 70mm to 90mm Width 10mm to 22mm

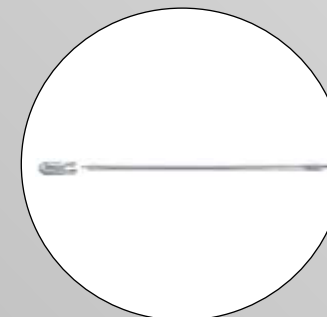

## Medullary Reamer

Size: 9mm to 15mm



## SAGGITAL SAW HANDPIECE

(Autoclavable) New and Improved saw allows for fine and faster cutting action with reduce vibrations Wider range of cutting options blade can be set 450 / 900 Specially scratch proof coated High quality Stainless Steel Blades for TKR, THR



## Chuck & Adapter



## Plaster Cutter - Electric

## DRILL & SAW SYSTEMS BATTERY OPERATED



### Shaver + Drill + Reamer and Saw

*Extra Unique Feature Drill hand piece, reamer hand piece and cutting saw hand piece can be attached and used on the same console which means it is ideal to be used for surgery like ACL, small joints, shoulder etc.*

#### Drill

- Ø Pjtupm "sn hsiq eftjho
- Ø Gjhi upsrvf bmmptx rvjdl esjmmjoh uispvhi fwfo the hardest cortical bone.
- Ø Sufbn mjofe ifbe eftjho qspwjefst nbyjnv visibility.
- Ø Evmmz dboovmbufe gps vtf xjui qjot boe hvjef wires
- Ø Bpowfojfou gpsxbse. sfwstf txjudi bmmptx rapid change in direction
- Ø Lpx tpvoe boe wjcsbujpo
- Ø Ljhiu xfjhiu\* fbtz up iboemf
- Ø Evmmz bvupdmbwbcmf jodmvejoh dbcmf
- Ø Eppu txjudi dpouspmmf
- Ø Ppxfs Svqqmz 9 12/ V (;B). 4/ Ga ° 0/&

#### Reamer

- Ø Pjtupm "sn hsiq eftjho
- Ø Qvjdl tobaq "uujoh joup mpdl dpmmbs
- Ø Evmmz dboovmbufe gps vtf xjui qjot boe hvjef wires.
- Ø Gjhi upsrvf bmmptx rvjdl esjmmjoh uispvhi fwfo the hardest cortical bone.
- Ø Lpx tpvoe boe wjcsbujpo
- Ø Ljhiu xfjhiu\* fbtz up iboemf
- Ø Susfbnmjof Gfbe hjwjoh hsfbufs wjtjpo
- Ø Evmmz bvupdmbwbcmf jodmvejoh dbcmf
- Ø Eppu txjudi dpouspmmf
- Ø Ppxfs Svqqmz 9 12/ V (;B). 4/ Ga ° 0/&

#### Saw

- Ø Snppui accurate cuts made for large variety of blade
- Ø Cfmjwfst vofrvbm qfbl qpxfs up rvjdlmz boe precisely cut the hardest bone.
- Ø Lpx tpvoe boe wjcsbujpo
- Ø Susfbnmjof Gfbe hjwjoh hsfbufs wjtjpo
- Ø Uojrvf wbsjbcmf tqffe usjhfst hsfbufs dpouspm-
- Ø Evmmz bvupdmbwbcmf jodmvejoh dbcmf
- Ø Eppu txjudi dpouspmmf
- Ø Ppxfs Svqqmz 9 12/ V (;B). 4/ Ga ° 0/&

## AUTOCLAVES & STERILIZERS



Please Visit Our WebSite  
[www.d4surgical.com](http://www.d4surgical.com)  
For Detail Specification & Further Information

[www.kiransurgicalsystems.com](http://www.kiransurgicalsystems.com)

## Rahabilitation Aids



**Item Name:** Finger Cot  
**Item Code:** D4s 12.001

- Ø Cftjhofe up jnncpcjmifif uif "ohfs gpmmpxjoh sfvedujpo of fractures of distal interphalangeal joints.
- Ø Sfswtf bt "ohfs qspufdups up hvbse bhhbjotu gvsuifs injury during healing process.
- Ø Pspufdujpo pg objm cfe jokvsjft pg "ohfst-
- Ø Mbef pg Suspoh `fyjcmf bmvnjojvn-



**Item Name:** Finger Cot  
**Item Code:** D4s 12.002

- Ø Cftjhofe up jnncpcjmifif uif "ohfs gpmmpxjoh sfvedujpo of fractures of distal interphalangeal joints.
- Ø Sfswtf bt "ohfs qspufdups up hvbse bhhbjotu gvsuifs injury during healing process.
- Ø Pspufdujpo pg objm cfe jokvsjft pg "ohfst-
- Ø Mbef pg Suspoh `fyjcmf bmvnjojvn-



**Item Name:** Frog Splint  
**Item Code:** D4s 12.003

- Ø Cftjhofe up jnncpcjmifif uif "ohfs gpmmpxjoh sfvedujpo of fractures of distal interphalangeal joints.
- Ø Sfswtf bt "ohfs qspufdups up hvbse bhhbjotu gvsuifs injury during healing process.
- Ø Pspufdujpo pg objm cfe jokvsjft pg "ohfst-



**Item Name:** Frog Splint  
**Item Code:** D4s 12.004

- Ø Mbef pg tuspoh `fyjcmf bmvnjojvn-
- Ø Gjhi efotjuz gpbm dpwfsjoh gps stfmmjofdf boe comfort
- Ø Ho nbmmfu "ohfs
- Ø Kffqt uif ejtubm jousqibmbhhfbbm kpjou jo ijhifs extension and proximal interphalangeal joint in `fyjpo-
- Ø Gpmet jousqibmbhhfbbm kpjout jo dpssfdu bmmjhonfou and prevent the deformity.



**Item Name:** Exercising Ball  
**Item Code:** D4s 12.005

- Ø Mbef vq gspn ijhi efotjuz PU svccfs gpbm-
- Ø ;wbjmbcmf jo eiggfsfou dpmpst pg dipjdf
- Ø Ufte cz qbsbmzuid qbujfout gps fyfstjdjoh pg xfbm ligaments.
- Ø Pptu gsbduvsf fyfstjdjoh pg xsjtu boe "ohfst-
- Ø Rpvoe tibqf jefbbm gps hsjqqjoh boe bqqmjdbujpo-

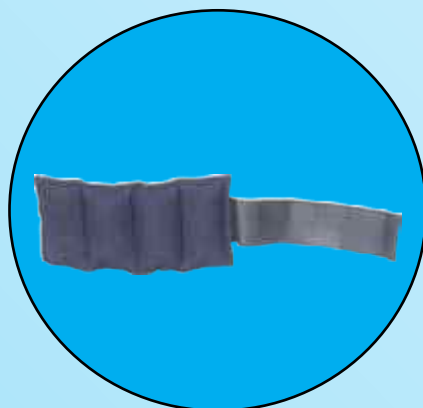

**Item Name:** Weight Cuff  
**Item Code:** D4s 12.006

- Made up of Fabric Material coverings.
- Double Safety hook and loop velcro closures for easy adjustment and secured fit.
- Vertically Sewed pockets permit cuff to bend freely to conform to any wrist or ankle contour.
- The cuff fits firmly and is comfortable to wear and easy to use.
- Weight cuff will not slip or slide off during most strenuous programme

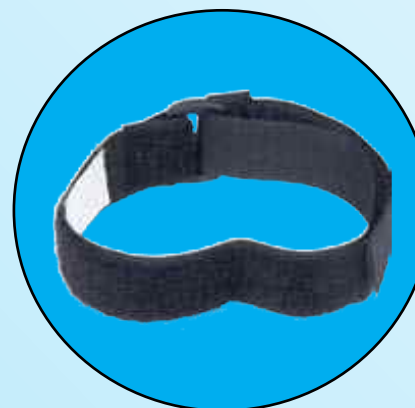

**Item Name:** Torniquete  
**Item Code:** D4s 12.009

- Use either for drawing blood or for intravenous injection.

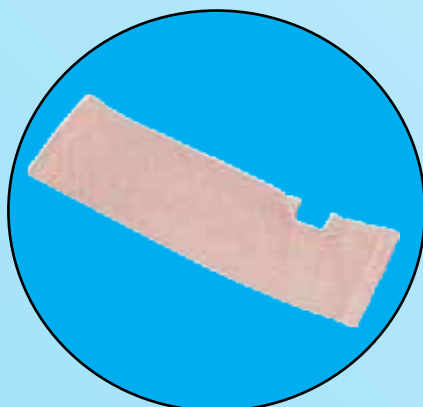

**Item Name:** Knee Cap  
**Item Code:** D4s 12.007

- Made of soft cotton yarns for comfort and prolonged use.
- Made up of heat resistant rubber.
- Ideal for arthritic conditions.
- Aid Stiff, swollen and painful knee caused by weakness or strain.
- Gives mild support and warmth.



**Item Name:** Lumbo Sacral Belt  
**Item Code:** D4s 12.010

- Made of durable cotton fabric with sturdy durable elastic for better fitness.
- Spring steel bars at the lumbosacral region for better immobilization, rigidity and firmness.
- Velcro closures provide close contour fitting around the waist, its easy application, adjustment and removal.
- Soft padding for better comfort.

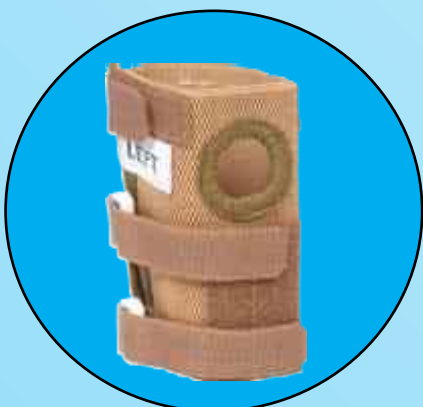

**Item Name:** Patella Knee Cap  
**Item Code:** D4s 12.008

- Made up of durable elastic with heat resistant rubber.
- Velcro enclosures for variable compression, easy application and removal.
- Plastic Hinges provided on both lateral sides for extra support and easy flexion.
- Nylon tape on lateral side to hold the hinges.
- To control painful knee movement in case of arthritis.
- Compression, support, and stability to painful knee due mild sprain, strain and patella injury



**Item Name:** Knee Brace  
**Item Code:** D4s 12.011

- Anatomically contoured back splints ensure rigid immobilization.
- Six straps of hook loop fasteners help in secured fitting & good immobilization.
- Patellar opening releases patellar pressure ensuring patient comfort.
- PUF fused strong fabric offers perfect cushioning for enhanced patient comfort and ensures long life of the product.
- Elasticized, removable patellar strap holds the patella in position and ensures secure immobilization of the knee joint.



**Item Name:** Cervical Pillow

**Item Code:** D4s 12.012

- Made of chosen material like open foam with cosy cover and zip embedding, firmness combined with softness and comforts.
- Used in surgical tables, at home, treatment tables etc.
- Made up of Vinyl or Cotton coverings
- Stimulates peripheral circulations.
- Relaxes muscles.
- Soothes, relieves and eliminates painful parts of body, neck, back



**Item Name:** Cast Shoe

**Item Code:** D4s 12.015

- Made up of high quality rexine outer-layered and cotton inner-lining.
- Velcro enclosures for firm grip, easy application and removal.
- Base made up of Rubber to avoid slipping.
- An ideal walking aid for patient whose leg is in plaster.
- Prevents plaster from chipping, cracking and soiling.
- Extremely light, tapered sole, not only restores the gait to normal but ensures better balance

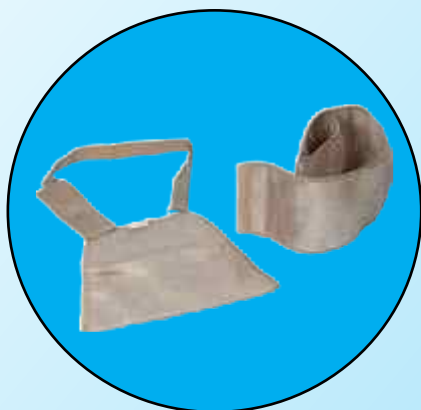

**Item Name:** Pouch Arm Sling

**Item Code:** D4s 12.013

- Simple to apply, easy to adjust.
- Just touch to close and peel to open.
- For strains and strains post fracture, bursitis, micro trauma, tenosynovitis, arthritis and other conditions.
- Requiring orthopedic support plus psychological assurance.
- Protects both wrist and upper bone.

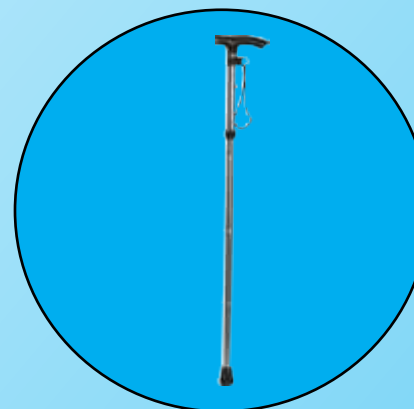

**Item Name:** Walking Stick

**Item Code:** D4s 12.016

- Made of high glossed anodized aluminium.
- Sticks made of locking silence for rattle free use complete with non skid rubber tips for long, safe wear.
- Grip Handles available in Wooden, PVC sleeve grip Ushape, L-shape foam grip, Moulded hand grip.
- The offset models and modified crook models properly position the line of force through the shaft and cant improving leverage and stability in gripping and weight bearing.
- Pin adjustment for varying lengths.
- Also available in CRC pipes with powder coating.



**Item Name:** : Rib Belt

**Item Code:** D4s 12.014

- A universal mens or womens rib belt, made of fine elastic for better fitness.
- Velcro closures provide contoured fitting around the chest and supports mild chest expansion as patient breathes, yet effectively controls rib cage
- Reduces the discomfort of sudden rib cage expansion from deep breathing, coughing or sneezing during recovery from rib injuries.

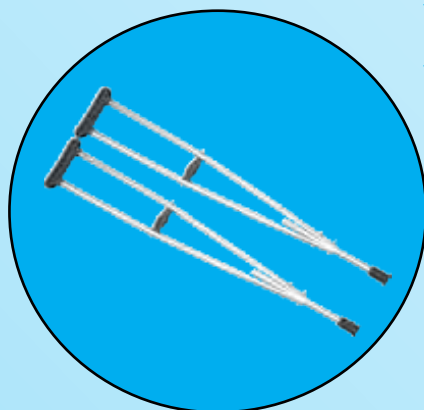

**Item Name:** Crutches  
**Item Code:** D4s 12.017

- Made of CRC pipes.
- Height adjustable without tools.
- Comfortable rubber cushioning and hand grip.
- High quality rubber shoe for firm ground grip and better life.
- Inside rubber shoe iron ring used to avoid damage to rubber shoe on continuous usage.
- Adjustable Crutches with models to cover youth, adult and tall adults ranges

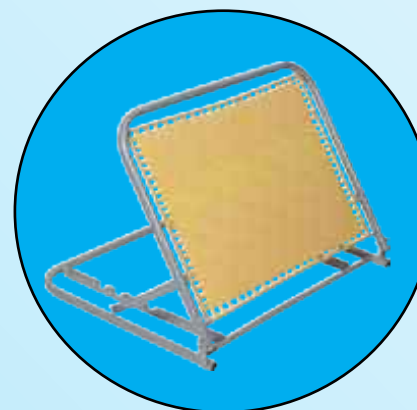

**Item Name:** Commode Chair  
**Item Code:** D4s 12.020

- Made of strong tubular pipes.
- Back Cushion made of nylon strips.
- Hinges provided for varying back positions
- Ideal for use in bed both in home and hospital.
- For patients requiring variable positions of back while doing various activities



**Item Name:** Quadripod Sticks  
**Item Code:** D4s 12.018

- Base legs set flat on floor and are equipped with shock absorbing safety cane tips and comfortable hand grip.
- Legs have less angulation to avoid tripping the user during walking movements.
- Made of high glossed anodised aluminium with powder coated base.
- Also available in CRC pipes with powder coating.
- Pin adjustment for varying lengths.
- Tripod and Quadripod Sticks are widely flared for greater balance as weight applied



**Item Name:** Wheel Chair  
**Item Code:** D4s 12.021

- For use on any smooth surface.
- Double ball bearings, provided for smooth rolling.
- Swinging detachable and adjustable foot rest.
- Easy handling breakes.
- Strong construction for durability and foldable for convenient handling.
- Available in chrome plating and powder coating.
- For paralytic patients not able to walk.
- For old Aged people.

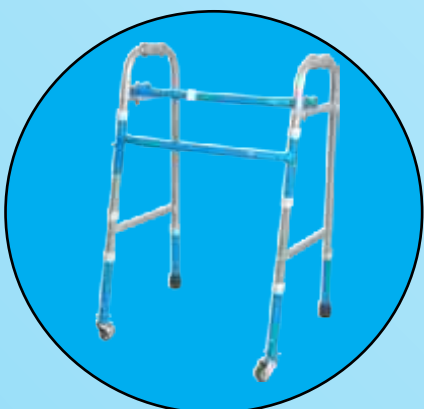

**Item Name:** Walker Fixed  
**Item Code:** D4s 12.019

- Made of high quality CRC pipe.
- Light weight and sturdy for the patients with limited physical strength.
- Powder Coated, complete with rubber foam grips and non skid rubber bottom tips.
- Bolted construction for tightening of joints, no rivets to break or loosen.
- Inside rubber shoe iron ring used to avoid damage to rubber shoe on continuous usage.
- Ideal walking aid.
- Used by leg fractured patients to support walking.



**Item Name:** Ankle Support  
**Item Code:** D4s 12.022

- Sturdy durable elastic (Towel) with Velcro enclosures applied as a figure 8 shaped bandage around the ankle.
- Ankle sprain and strain.
- Ligamentous injuries.
- Flacid foot drop.



**Item Name:** Commode Chair

**Item Code:** D4s 12.023

- Made of strong tubular pipes.
- Back Cushion made of nylon strips.
- Hinges provided for varying back positions.
- Ideal for use in bed both in home and hospital.
- For patients requiring variable positions of back while doing various activities

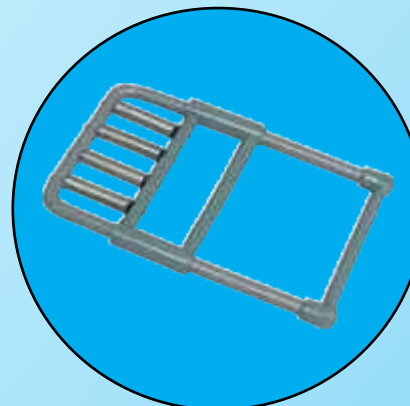

**Item Name:** Hand Exerciser

**Item Code:** D4s 12.026

- Made of high quality plastic in assorted colors.
- Zinc plated springs of uniform stretching.
- Easy removal or addition of springs for varying degree of exercise.
- Used by paralytic patients for exercising of weak ligaments.
- Post fracture exercising of wrist and fingers.



**Item Name:** Commode Chair (Folding)

**Item Code:** D4s 12.024

- Made of CRC pipe.
- Powder coated acting as water proof for the pipe.
- Light weight and sturdy ideally to be carried anywhere with ease.
- Quality plastic cover ,to cover when not in use.
- Used as bed side toilet sheet.
- Ideal for Hospital, Nursing home and home use.
- Easily carried when travelling



**Item Name:** Cervical Collar

**Item Code:** D4s 12.027

- Designed to support, immobilize or adjust the neck in the flexion, extension or hyperextension position.
- Designed to support, immobilize or adjust the neck in the flexion, extension or hyperextension position.
- High density Polyurethane Foam (P.U.F.) with cotton stockinette covering for comfort.
- Polythene sheet reinforcement for better immobilization.
- Ventilation through Eyelet to allow air circulation for comfort.
- Velcro closures for easy application, removal and adjustir circulation for comfort.

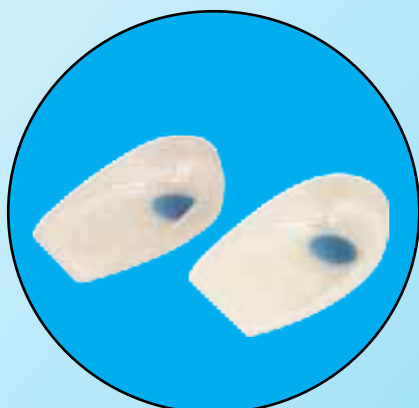

**Item Name:** : Heel Cushion

**Item Code:** D4s 12.025

- Made of soft non irritant rubber material.
- Used as natural shock absorber to avoid shock waves transmitted to heel, foot, knee ,hips and the back.
- Ideal for treatment of plantar fasciitis and can be worn to prevent injury to heel bone.



**Item Name:** Philadelphia Collar

**Item Code:** D4s 12.028

- Two pieces semi rigid collar, Velcro enclosures made of EVA sheet.
- Rigid plastic reinforcement in both pieces with trancel opening.
- No metal parts, X-ray can be taken easily.
- Shaped for complete immobilization of cervical region.
- Cervical disc diseases.
- Cervical Spondylosis.
- Early rheumatoid diseases of cervical region.
- Stabilization or hyperextension of cervical region



**Item Name:** Abdominal Belt

**Item Code:** D4s 12.031

- Made of durable cotton fabric with sturdy elastic for contour and anterior compression over abdomen.
- Velcro closures provide close contour fitting around the waist, its easy application, adjustment and removal.
- Post operative conditions of abdomen.
- Post delivery cases, Umbilical and Ventral Hernia.
- As a Tummy Trimmer.

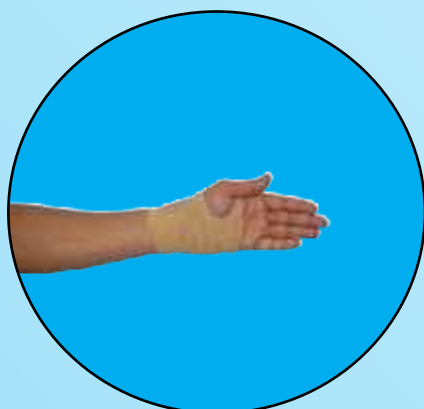

**Item Name:** Wrist Brace

**Item Code:** D4s 12.029

- Simple to apply, easy to adjust.
- Just touch to close and peel to open.
- For strains and strains post fracture, bursities micro-trauma, tenosynovitis, arthritis and other conditions.
- Requiring orthopedic support plus psychological assurance.
- Protects both wrist and upper bone.



**Item Name:** Knee Brace

**Item Code:** D4s 12.032

- Made up of water proof cloth outer covering and soft inner cotton lining for firmness and comfort.
- Spring Steel Bars for immobilisation and straightening.
- Lastic tape with Velcro Enclosures for easy application and removal.
- Protecting the injured knee joint in emergency.
- Stabilising surgically or non surgically treated knee joint for strain, sprain and fracture dislocation.
- Early Cast removal.
- Used during Physiotherapy.



**Item Name:** Pouch Arm Sling

**Item Code:** D4s 12.030

- Adjustable sling with a protective pouch to replace the conventional sling.
- Made of durable Cotton fabric and Nylon straps.
- Velcro rejoinders allow quick and easy adjustment of the arm.
- Used for comfortably supporting the sprained, broken or surgically operated arm while it recuperates.
- Smart and convenient method to protect the plastered arm.



**Item Name:** Clavicle Brace

**Item Code:** D4s 12.033

- Applied as figure 8 shaped bandages with straps and lock.
- Made out of hypo-allergenic stockinette padded with Polyurethane Foam.
- Straps allow a very strong fitting of the brace around the clavicular region for its proper binding.
- S.R. Lock do not allow the loosening of the brace.

**Item Name:** Vaccine carriers

**Item Code:** D4s13.001



Vaccine storage capacity	2.00 liter
Weight fully loaded	2.200 Kg
Weight empty	0.550 Kg
External surface material	Wax coated box and plastic lid
Internal lining material	Polyethyiene
Insulation material	CFC Free Polyurethane
Insulation thickness	30 mm
External dimensions (W x D x H)	23.5 x 16.6 x 26.6 cm
Internal dimensions (W x D x H)	16.8 x 9.7 x 19 cm
Vaccine storage dimensions	16.8 x 9.7 x 12.4 cm
Lid type & fixings	Folded & Fastened with a tie
Number of icepacks required	2
Number of icepacks supplied	2
Volume of icepack	0.350 liter

**Item Name:** Vaccine carriers

**Item Code:** D4s13.002



Vaccine storage capacity	1.600 liter
Weight fully loaded	4.300 Kg
Weight empty	1.900 Kg
External surface material	H.D.P.E
Internal lining material	HIPS
Insulation material	CFC Free Polyurethane
Insulation thickness	40/35 mm
External dimensions (W x D x H)	25x25x29 cm
Internal dimensions (W x D x H)	16x16x19 cm
Vaccine storage dimensions	10X10X16 cm
Lid type & fixings	Removable
Number of icepacks required	4
Number of icepacks supplied	4
Volume of icepack	0.350 liter

## VACCINE CARRIERS

# COLD BOXES

**Item Name:** Cold Boxes  
**Item Code:** D4s13.003



Vaccine storage capacity	23.120 liter
Weight fully loaded	48.900 Kg
Weight empty	18.600 Kg
External surface material	L.L.D.P.E
Internal lining material	L.L.D.P.E
Insulation material	CFC Free Polyurethane
Insulation thickness	100 mm
External dimensions (W x D x H)	77x62x52 cm
Internal dimensions (W x D x H)	51x36x27 cm
Vaccine storage dimensions	45x30x18 cm
Lid type & fixings	Hinged
Number of icepacks required	50
Number of icepacks supplied	50
Volume of icepack	0.30 liter

**Item Name:** Cold Boxes  
**Item Code:** D4s13.004



Vaccine storage capacity	21.800 liter
Weight fully loaded	50.500 Kg
Weight empty	18.600 Kg
External surface material	L.L.D.P.E
Internal lining material	L.L.D.P.E
Insulation material	CFC Free Polyurethane
Insulation thickness	100 mm
External dimensions (W x D x H)	77x62x52 cm
Internal dimensions (W x D x H)	51x36x27 cm
Vaccine storage dimensions	45x30x18 cm
Lid type & fixings	Hinged
Number of icepacks required	31
Number of icepacks supplied	31
Volume of icepack	0.575 liter

**Item Name:** Cold Boxes  
**Item Code:** D4s13.005



Vaccine storage capacity	5.000 liter
Weight fully loaded	25.000 Kg
Weight empty	11.800 Kg
External surface material	L.L.D.P.E
Internal lining material	L.L.D.P.E
Insulation material	CFC Free Polyurethane
Insulation thickness	100 mm
External dimensions (W x D x H)	79x41x43 cm
Internal dimensions (W x D x H)	58x18x20 cm
Vaccine storage dimensions	50x10x10 cm
Lid type & fixings	Hinged
Number of icepacks required	26
Number of icepacks supplied	26
Volume of icepack	0.300 liters

# ICE PACKS

**Item Name:** Ice Packs  
**Item Code:** D4s 13.006,07,08



Item Code: D4s 13.006	<b>0.6 liters</b>
Volume of ice per pack	0.575 liter
External dimensions	191 x 122 x 34mm
Weight Empty	109 gram
Weight Filled	672 gram

Item Code: D4s 13.007	<b>0.4 liters</b>
Volume of ice per pack	0.350 liter
External dimensions	163 x 96 x 33 mm
Weight Empty	80 gram
Weight Filled	428 gram

Item Code: D4s 13.008	<b>0.3 liters</b>
Volume of ice per pack	0.310 liter
External dimensions	163 x 90 x 33 mm
Weight Empty	79 gram
Weight Filled	389 gram

## HOSPITAL HOLLOW WARE, SS



**Item Name:** instrument tray with / without Cover  
**Item Code:** D4s14.001 to D4s14.012

**Material of Construction:**  
 Stainless Steel: STANDARD - 0.4 mm 202 grade  
 / DELUXE - 0.5 mm 202 grade / SUPREME -  
 18/8 gauge 304 grade



**Item Name:** Kidney Tray with/ without Cover  
**Item Code:** D4s14.013 to D4s14.016

**Material of Construction:**  
 Stainless Steel: STANDARD - 0.4 mm 202 grade  
 / DELUXE - 0.5 mm 202 grade / SUPREME -  
 18/8 gauge 304 grade

SIZE		Standard
In Inch	In mm	
8 x 6	203 x 150	D4s12.001
10 x 8	254 x 203	D4s12.002
11 x 9	279 x 229	D4s12.003
12 x 9	305 x 229	D4s12.004
14 x 10	356 x 254	D4s12.005
18 x 12	457 x 305	D4s12.006
9 x 6	229 x 152	D4s12.007
11 x 7	279 x 178	D4s12.008
12 x 8	305 x 203	D4s12.009
12 x 10	305 x 254	D4s12.010
15 x 12	381 x 305	D4s12.011
8 x 12	203 x 305	D4s12.012

SIZE		Standard
In Inch	In mm	
6	152	D4s12.013
8	203	D4s12.014
10	254	D4s12.015
12	305	D4s12.016



**Item Name:** Douche Can  
**Item Code:** D4s14.017 - D4s14.019

**Material of Construction:**  
Stainless Steel: STANDARD - 0.4 mm 202 grade / DELUXE - 0.5 mm 202 grade / SUPREME - 18/8 gauge 304 grade

D4s12.017	1 Liter Capacity
D4s12.018	1.5 Liter Capacity
D4s12.019	2 Liter Capacity
Available with fittings also	



**Item Name:** Graduated Jar/ Measuring jug  
**Item Code:** D4s14.020 - D4s14.022

**Material of Construction:**  
Stainless Steel: STANDARD - 0.4 mm 202 grade / DELUXE - 0.5 mm 202 grade / SUPREME - 18/8 gauge 304 grade

D4s12.020	500ml Capacity
D4s12.021	1000ml Capacity
D4s12.022	1500ml Capacity



**Item Name:** Urinal - Male  
**Item Code:** D4s14.023

**Material of Construction:**  
Stainless Steel: STANDARD - 0.4 mm 202 grade / DELUXE - 0.5 mm 202 grade / SUPREME - 18/8 gauge 304 grade

## HOSPITAL HOLLOW WARE, SS



**Item Name:** Urinal - Female  
**Item Code:** D4s14.024

• Sizes/ designs/ specifications/ thickness of the above are liable to change as per specific requirement of buyers.

**Material of Construction:**  
Stainless Steel: STANDARD - 0.4 mm 202 grade / DELUXE - 0.5 mm 202 grade / SUPREME - 18/8 gauge 304 grade



**Item Name:** Feeding Cup  
**Item Code:** D4s14.025

**Material of Construction:**  
Stainless Steel: STANDARD - 0.4 mm 202 grade / DELUXE - 0.5 mm 202 grade / SUPREME - 18/8 gauge 304 grade



**Item Name:** Dressing Jar  
**Item Code:** D4s14.026 - D4s14.027

**Material of Construction:**  
Stainless Steel: STANDARD - 0.4 mm 202 grade  
/ DELUXE - 0.5 mm 202 grade / SUPREME -  
18/8 gauge 304 grade

Capacity	Size	Standard
1 Liter	100x100mm	d4s14.026
2 Liter	150x150mm	d4s14.027



**Item Name:** Bed Pan – Female (Jointed)  
**Item Code:** D4s14.030

**Material of Construction:**  
Stainless Steel: STANDARD - 0.4 mm 202 grade  
/ DELUXE - 0.5 mm 202 grade / SUPREME -  
18/8 gauge 304 grade



**Item Name:** Sputum Mug  
**Item Code:** D4s14.028

**Material of Construction:**  
Stainless Steel: STANDARD - 0.4 mm 202 grade  
/ DELUXE - 0.5 mm 202 grade / SUPREME -  
18/8 gauge 304 grade



**Item Name:** Bed Pan-Female (Seamless)  
**Item Code:** D4s14.031

**Material of Construction:**  
Stainless Steel: STANDARD - 0.4 mm 202 grade  
/ DELUXE - 0.5 mm 202 grade / SUPREME -  
18/8 gauge 304 grade



**Item Name:** Medicine Cup  
**Item Code:** D4s14.029

**Material of Construction:**  
Stainless Steel: STANDARD - 0.4 mm 202 grade  
/ DELUXE - 0.5 mm 202 grade / SUPREME -  
18/8 gauge 304 grade

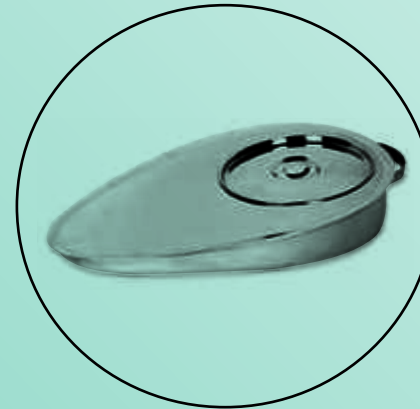

**Item Name:** Bed Pan – Male (Jointed)  
**Item Code:** D4s14.032

**Material of Construction:**  
Stainless Steel: STANDARD - 0.4 mm 202 grade  
/ DELUXE - 0.5 mm 202 grade / SUPREME -  
18/8 gauge 304 grade

## HOSPITAL HOLLOW WARE, SS



**Item Name:** Galli – Pot with Cover

**Item Code:** D4s14.033-d4s14.034

**Material of Construction:**

Stainless Steel: STANDARD - 0.4 mm 202 grade  
/ DELUXE - 0.5 mm 202 grade / SUPREME -  
18/8 gauge 304 grade

Size	in	Capacity	Deluxe
3	76	4 OZ	d4s14.033
3.5	89	6 OZ	d4s14.034



**Item Name:** Lotion Bowl

**Item Code:** D4s14.035 - D4s14.040

**Material of Construction:**

Stainless Steel: STANDARD - 0.4 mm 202 grade  
/ DELUXE - 0.5 mm 202 grade / SUPREME -  
18/8 gauge 304 grade

In Inch	In mm	Standard
3	75	D4s14.035
4	100	D4s14.036
4.75	120	D4s14.037
6	150	D4s14.038
7	180	D4s14.039
8	200	D4s14.040



**Item Name:** Catheter tray with Cover

**Item Code:** D4s14.041 - D4s14.042

**Material of Construction:**

Stainless Steel: STANDARD - 0.4 mm 202 grade  
/ DELUXE - 0.5 mm 202 grade / SUPREME -  
18/8 gauge 304 grad

In Inch	In mm	Standard
8x 3	203 x 76	D4s12.041
16x 4	406 x 102	D4s12.042

# HOSPITAL HOLLOW WARE, SS



**Item Name:** Dressing Drum Jointless (Seamless)

**Item Code:** D4s14.043 - D4s14.066

**Material of Construction:**

Stainless Steel: STANDARD - 0.4 mm 202 grade / DELUXE - 0.5 mm 202 grade / SUPREME - 18/8 gauge 304 grade



**Item Name:** Dressing Drum Jointed

**Item Code:** D4s14.067 - D4s14.085

**Material of Construction:**

Stainless Steel: STANDARD - 0.4 mm 202 grade / DELUXE - 0.5 mm 202 grade / SUPREME - 18/8 gauge 304 grade

SIZE		SEAMLESS	JOINTED
In Inch	In mm		
6 X 4	152 x 102	D4s14.043	D4s14.062
6 X 6	152 x 152	D4s14.044	D4s14.063
7 X 5	178 x 127	D4s14.045	D4s14.064
8 X 6	203 x 152	D4s14.046	D4s14.065
8 X 8	203 x 203	D4s14.047	D4s14.066
9 X 5	241 x 127	D4s14.048	D4s14.067
9 X 9	241 x 241	D4s14.049	D4s14.068
11 X 5	279 x 127	D4s14.050	D4s14.069
11 X 9	305 x 241	D4s14.051	D4s14.070
12 X 9	305 x 254	D4s14.052	D4s14.071
12 X 10	305 x 305	D4s14.053	D4s14.072
12 X 12	356 x 305	D4s14.054	D4s14.073
14 X 5	356 x 305	D4s14.055	D4s14.074
14 X 9	356 x 127	D4s14.056	D4s14.075
14 X 10	305 x 241	D4s14.057	D4s14.076
14 X 12	305 x 254	D4s14.058	D4s14.077
15 X 9	305 x 305	D4s14.059	D4s14.078
15 X 10	305 x 241	D4s14.060	D4s14.079
15 X 12	305 x 305	D4s14.061	D4s14.080

## HOSPITAL HOLLOW WARE, SS



**Item Name:** Dustbin Pedestal with Plastic bucket

**Item Code:** D4s14.086 - D4s14.088

**Material of Construction:**

Stainless Steel: STANDARD - 0.4 mm 202 grade / DELUXE - 0.5 mm 202 grade / SUPREME - 18/8 gauge 304 grade

5 liter capacity	D4s14.086
7.5 liter capacity	D4s14.087
12 liter capacity	D4s14.088



**Item Name:** Basins

**Item Code:** D4s14.089 - D4s14.091

**Material of Construction:**

Stainless Steel: STANDARD - 0.4 mm 202 grade / DELUXE - 0.5 mm 202 grade / SUPREME - 18/8 gauge 304 grade

SIZE		Regular (Light Base)
In Inch	In mm	
12	300	D4s14.089
14	350	D4s14.090
16	400	D4s14.091



**Item Name:** Forcep - Jar/Thermometer Jar

**Item Code:** D4s14.092 - D4s14.097

**Material of Construction:**

Stainless Steel: STANDARD - 0.4 mm 202 grade / DELUXE - 0.5 mm 202 grade / SUPREME - 18/8 gauge 304 grade

SIZE		Regular (Light Base)	Deluxe (Heavy Base)
In Inch	In mm		
2 X 7	50 x 185	D4s14.092	D4s14.095
3 X 8	75 x 200	D4s14.093	D4s14.096
4 X 8	100 x 200	D4s14.094	D4s14.097



**Item Name:** Urine Pot Large 2 In 1  
**Item Code:** D4s14.098

**Material of Construction:**  
Polypropylene/ High Density polyethylene / Low density polyethylene



**Item Name:** Stool Container  
**Item Code:** D4s14.101

• Sizes/ designs/ specifications/ thickness of the above are liable to change as per specific requirement of buyers.

**Material of construction:**  
Polypropylene/ High Density polyethylene / Low density polyethylene



**Item Name:** Bed Pan  
**Item Code:** D4s14.099

**Material of Construction:**  
Polypropylene/ High Density polyethylene / Low density polyethylene



**Item Name:** Steam Inhaler  
**Item Code:** D4s14.102

• Sizes/ designs/ specifications/ thickness of the above are liable to change as per specific requirement of buyers.

**Material of construction:**  
Polypropylene/ High Density polyethylene / Low density polyethylene



**Item Name:** Urine Pot Large- Male  
**Item Code:** D4s14.100

**Material of Construction:**  
Polypropylene/ High Density polyethylene / Low density polyethylene

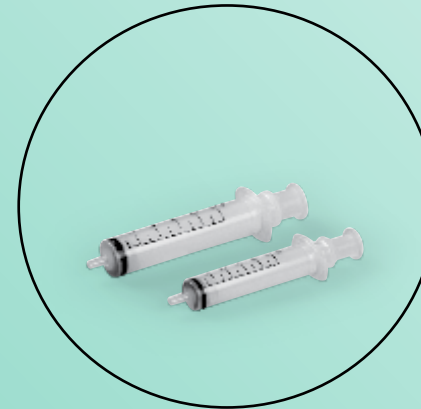

**Item Name:** Veterinary Syringes  
**Item Code:** D4s12.098

• Sizes/ designs/ specifications/ thickness of the above are liable to change as per specific requirement of buyers.

**Material of construction:**  
Polypropylene/ High Density polyethylene / Low density polyethylene

## HOSPITAL HOLLOW WARE, PP



**Item Name:** Kidney Tray

**Item Code:** D4s14.103

- Unbreakable, autoclavable, rounded edges with no sharp corners, superior finish, reusable. Sizes - 8/ 200mm, 10/250mm and 12/300mm. Available in white, transparent and blue colours.

**Material of construction:**

Polypropylene/ High Density polyethylene / Low density polyethylene



**Item Name:** Measuring Cup-graduated, conical shape

**Item Code:** D4s14.104

- Sizes/ designs/ specifications/ thickness of the above are liable to change as per specific requirement of buyers.

**Material of construction:**

Polypropylene/ High Density polyethylene / Low density polyethylene



**Item Name:** Specimen Container

**Item Code:** D4s14.105

- Sizes/ designs/ specifications/ thickness of the above are liable to change as per specific requirement of buyers.

**Material of construction:**

Polypropylene/ High Density polyethylene / Low density polyethylene

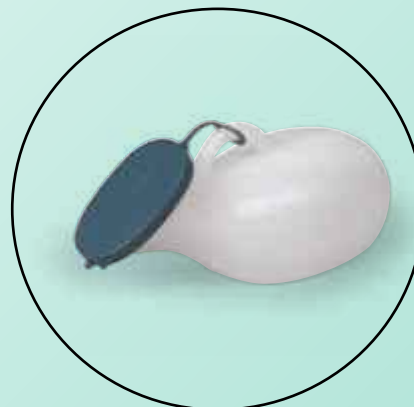

**Item Name:** Urine Pot Female

**Item Code:** D4s14.106

- Sizes/ designs/ specifications/ thickness of the above are liable to change as per specific requirement of buyers.

**Material of construction:**

Polypropylene/ High Density polyethylene / Low density polyethylene



**Item Name:** Urine Pot Male

**Item Code:** D4s14.107

- Sizes/ designs/ specifications/ thickness of the above are liable to change as per specific requirement of buyers.

**Material of construction:**

Polypropylene/ High Density polyethylene / Low density polyethylene

## LABORATORY CONSUMABLES

LABORATORY GLASS WARE - FLASK, BEAKERS, TEST TUBES & OTHERS ETC.

LABORATORY PLASTIC WARE - TEST TUBE STAND, PETRI DISH, MICRO PIPPETS ETC.

LABORATORY DISPOSABLE - MICROSCOPE SLIDES, COVER SLIP, LANCETS ETC.

LABORATORY EQUIPMENTS - HOT AIR OVEN, CENTRIFUGE MACHINE, BLOOD CELL COUNTER ETC.

LABORATORY CHAMICALS AND REAGENTS.

Please Visit Our WebSite

[www.kiransurgicalsystems.com](http://www.kiransurgicalsystems.com)

For Detail Specification & Further Information

[www.kiransurgicalsystems.com](http://www.kiransurgicalsystems.com)

## MICROSCOPES

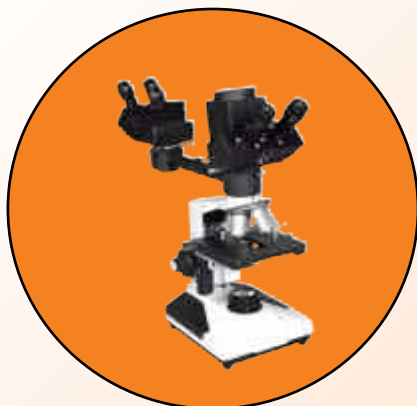

**Item Name:** Dual Viewing Microscope With in-Built CCD Camera

**Item Code:** D4s 15.001

Sizes/ designs/ specifications of the above are liable to change as per specific requirement of buyers.

**Intended Use:** This Microscope is intended for university and medical uses. New dual head Binocular Teaching Microscope is designed for the advance academic research environment. The dual Binocular head provides two persons viewing for coordinated study of biological specimens and photography simultaneously. Two students or instructors and students are able to view the same specimen for immediate observation result.



**Item Name:** Monocular Microscope

**Item Code:** D4s 15.004

**Intended Use:**

To be used in school/colleges by students. Pathological uses can also be done. Monocular Microscope is Economical & provides the necessary specifications for Educational & Diagnostic use.

**Material of construction:**

- Brass
- Pressure Dye Cast
- ABS Plastic
- Glass



**Item Name:** Binocular Advance Research Microscope

**Item Code:** D4s 15.002

**Intended Use:**

To be used for research and pathological purposes.

**Material of construction:**

- Brass
- Pressure Dye Cast
- ABS Plastic
- Glass



**Item Name:** Simple Inclined Microscope

**Item Code:** D4s 15.005

**Intended Use:**

To be used for research and pathological purposes. This Microscope provides the necessary specifications for educational, Diagnostic & Industrial Laboratories uses.

**Material of construction:**

- Brass
- Pressure Dye Cast
- ABS Plastic
- Glass



**Item Name:** Simple Inclined Binocular Microscope

**Item Code:** D4s 15.003

**Intended Use:**

To be used in school/colleges by students. This Binocular Microscope provides the necessary specifications for Educational, Diagnostic & Industrial Laboratories uses.

**Material of construction:**

- Brass
- Pressure Dye Cast
- ABS Plastic
- Glass

# RESUSCITATORS

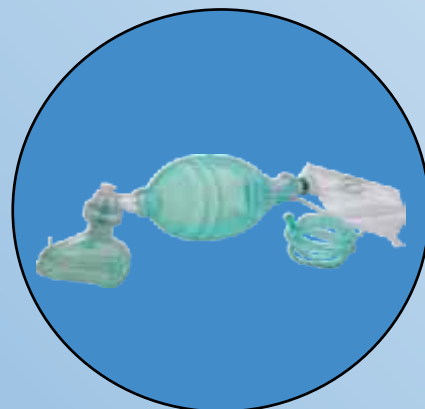

**Item Name:** Resuscitators, Silicon, Adult

**Item Code:** D4s 16.001

- Compact resuscitators for emergency respiration. These are made from silicon rubber and autoclavable up to 136°C.
- Supplied with mask, oxygen reservoir and oxygen tube. Colours: Green, White and Blue.

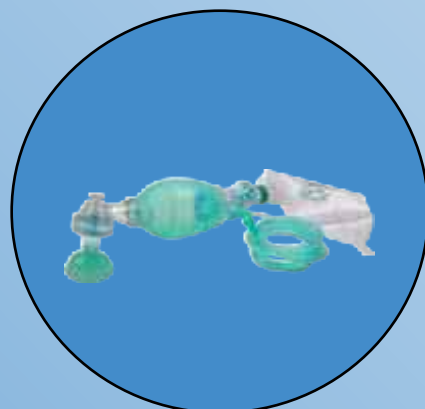

**Item Name:** Resuscitators, Silicon, Child

**Item Code:** D4s 16.002

- Compact resuscitators for emergency respiration. These are made from silicon rubber and autoclavable up to 136°C.
- Supplied with mask, oxygen reservoir and oxygen tube. Colours: Green, White and Blue

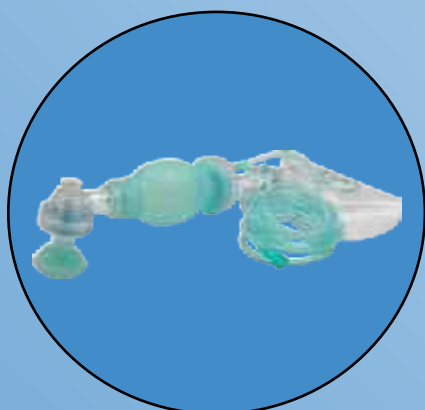

**Item Name:** Resuscitators, Silicon, Infant

**Item Code:** D4s 16.003

- Compact resuscitators for emergency respiration. These are made from silicon rubber and autoclavable up to 136°C.
- Supplied with mask, oxygen reservoir and oxygen tube. Colours: Green, White and Blue

Code	Size	Bellow Capacity	Oxygen Reservoir Capacity	Face Mask
D4s 16.001	Adult	1500 ml.	2600 ml.	Size # 4

Code	Size	Bellow Capacity	Oxygen Reservoir Capacity	Face Mask
D4s 16.002	Child	500 ml.	700 ml.	Size # 1

Code	Size	Bellow Capacity	Oxygen Reservoir Capacity	Face Mask
D4s 16.003	Infant	250 ml.	500 ml.	Size # 0

Part Name	Material
Bellow	Silicon Rubber
Masks	00, 0, 1 & 2 All Silicon Rubber 3, 4 & 5 Polycarbonate and Silicon Rubber
Non-Return Valve	Polycarbonate
Non-Return Valve Diaphragm	Silicon Rubber
Reservoir Valve	Polycarbonate
Reservoir Diaphragm	Silicon Rubber
Oxygen Reservoir Bag	PVC*
Oxygen Tube & Adaptor	PVC*

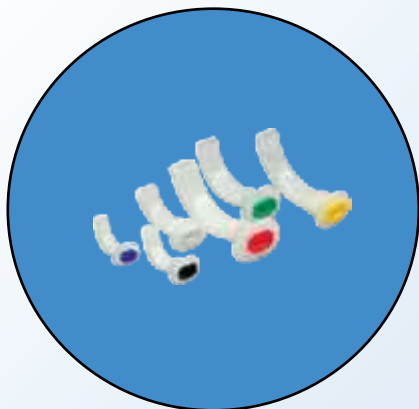

**Item Name:** Guidel Airway

**Item Code:** D4s16.004

- Made from EVA. Pyrogen free and non-toxic. can also be made from Low Density Polyethylene colour coded for easy identification

00	Blue (New born)
0	Black (Child
1	White (Child - large
2	Green (Adult -small)
3	Yellow (Adult - Medium)
4	Red (Adult - large)

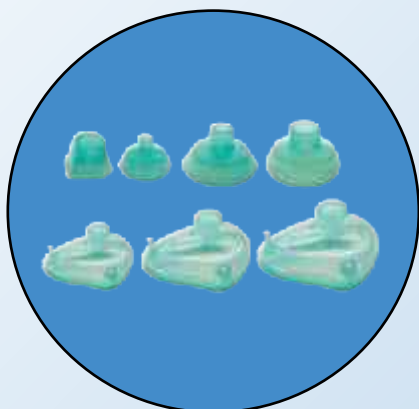

**Item Name:** Masks, Silicon

**Item Code:** D4s16.005

00	Premature)
0	Infant
1	Child
2	Adult -Small
3	Adult - medium
4	Adult - large
5	Adult - Extra large

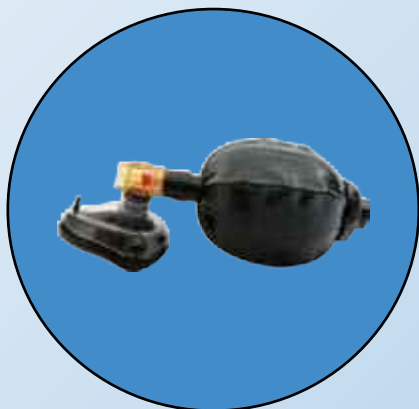

**Item Name:** Resuscitators, Ambu Type

**Item Code:** D4s16.006

- Adult, double chamber, supplied with mask # 4.

00	Blue (New born)
0	Black (Child
1	White (Child - large
2	Green (Adult -small)
3	Yellow (Adult - medium)
4	Red (Adult - large)

## LARYNGOSCOPE



**Item Name:** Handles

**Item Code:** D4s16.007 - D4s16.008

Code	Handle
07	Paediatric Ø18mm (Batteries - 2 x type AA)
08	Medium Ø28mm (Batteries - 2 x type C)

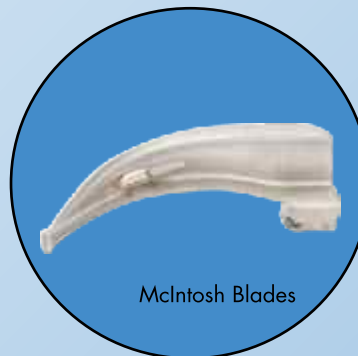

McIntosh Blades

**Item Name:** McIntosh Blades / Miller Blades

**Item Code:** D4s16.009 - D4s16.010

Size	MaIntosh	Miller
00		64mm
0	73mm	77mm
1	93mm	103mm
2	103mm	152mm
3	130mm	180mm
4	151mm	203mm
5	173mm	

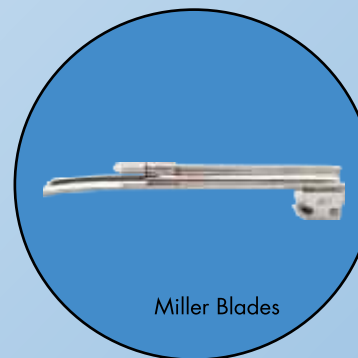

Miller Blades



**Item Name:** Latex Surgical/ Examination Gloves

**Item Code:** D4s 17.001

- Made from natural rubber Latex.
- Non finger fatigue keeps the hand cool & comfortable.
- Slightly Powdered.
- Micro rough-finish for better grip.
- Sizes  
Surgical Gloves - 6, 6.5, 7, 7.5, 8  
Examination Gloves - S, M, L

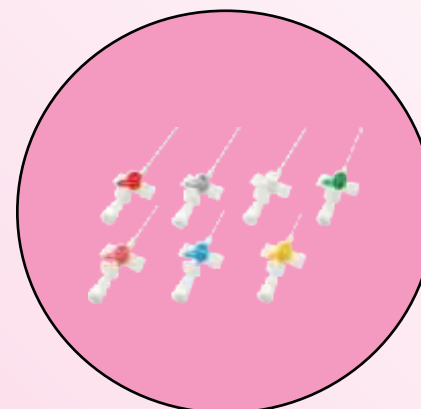

**Item Name:** I V Cannula

**Item Code:** D4s 17.004

- I.V. Cannula with Injection Port & Wings, Sterile
- I.V. Cannula Without Injection Port, With Wings, Sterile
- I.V. Cannula Without Injection Port, Without Wings, Sterile
- Sizes: 14g, 16g, 17g, 18g, 20g, 22g, 24g



**Item Name:** Syringe Disposable

**Item Code:** D4s 17.002

- 1ml, 2ml, 3ml, 5ml, 10ml, 20ml, 50ml
- Available With Luer Lock and Luer Slip
- Available With Needle Sizes 16g, 18g, 19g, 21g, 22g, 23g, 24g, 25g, 26g, 27g

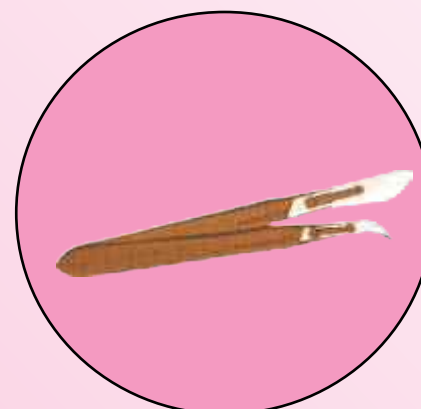

**Item Name:** Scalpels Disposable

**Item Code:** D4s 17.005

- Stainless Steel Blade Fitted in graduated plastic handle.
- Blade Protected by Plastic Cap
- Supplied in individual pack, 10 Pcs in a Box
- Sizes - 10, 10A, 11, 11P, 12, 12B, 12D, 14, 15, 15C, 16, 17, 18, 19, 20, 21, 22, 23



**Item Name:** Scalp vein set

**Item Code:** D4s 17.003

- Scalp vein set manufactured from non-toxic, medical grade pvc compound. Non-traumatic penetration.
- Available in different sizes - 18g, 19g, 20g, 22g, 23g, 24g, 25g

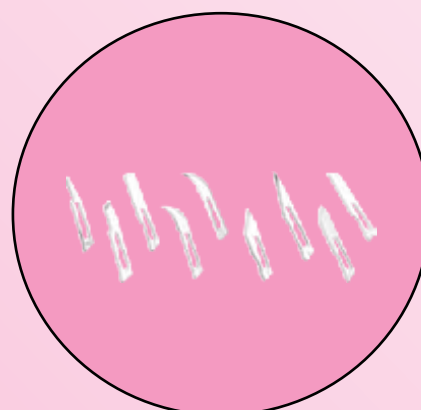

**Item Name:** Surgical Blades

**Item Code:** D4s 17.006

- Surgical Blades available in carbon steel and SS
- Individually Packed in Aluminium Foil
- Sizes - 10, 10A, 11, 11P, 11k, 12, 12B, 14, 15, 15C, 16, 18, 19, 20, 21, 22, 23, 24, 25, 26

## SUCTION UNITS



**Item Name:** Suction machine, heavy duty, electric 2 lts

**Item Code:** D4s18.001

- Portable suction machine, electric 230V/50Hz-230/60Hz.
- Phase, with safety fuse and shock resistance case. Suction power of 32lt/min,
- Trap bottle system 1litre suction bottle/jar auto clavable with overflow valve.
- Suction regulator and vacuum gauge
- Complete with carrying handle, 1.8m rubber tubing cord, antibacterial filter, plug and one spare suction bottle of one litre.



**Item Name:** Suction Pump Foot Hand operated

**Item Code:** D4s18.002

- Max vacuum 550 mm hg,
- Twin bottle each with capacity of 600ml.
- Positive negative valve, for adult and child use with suction tip,
- Instruction manual in English language



**Item Name:** Suction pump electric

**Item Code:** D4s18.003

- Portable medical device for surgical aspiration electric 240 volt/50/60 hz, 14v dc 4.3
- A.free flow 30 lit/min max vacuum 0= 0.85 bar (0.85 kpa) adjustable.
- Noise level approx 65 dba
- upto 45 min of autonomy with fully charged battery
- Autoclavable polycarbonate jar 1000 cc with safety valve (overflow protection)



**Item Name:** Suction machine, heavy duty, electric 6 lts

**Item Code:** D4s 18.004

- Double bottle explosion proof suction device for the operating theatre use.
- To produce a minimum vacuum of 600 - 650mmHg at the bottle top suction inlet.
- Fitted with 2m of Anti-static autoclavable suction tubing, a vacuum gauge, scaled in mmHg,
- Two transparent cylindrical jars, 3 litre capacity and scaled in graduations to 3000mm; Changeover valve in the circuit to allow alternate filling of the jars,
- Quick control unit to prevent the liquid flowing back into the pump;

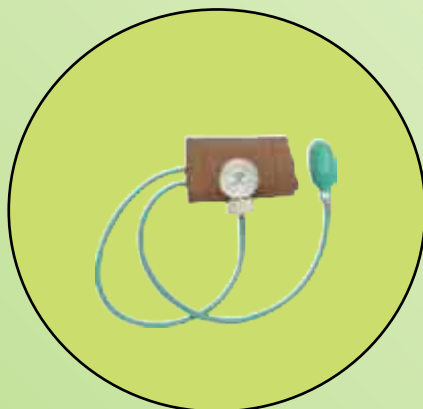

**Item Name:** Sphygmomanometer, Aneroid

**Item Code:** D4s 19.001

- A compact and reliable Sphygmomanometer supplied with adult velcro fabric cuff and precision manometer with clip for fixing to cuff. Range: 0-300mmHg, packed in soft vinyl case



**Item Name:** Stethoscope

**Item Code:** D4s 19.004

- STETHOSCOPE, mono  
High sensitivity chest-piece with translucent mic diaphragm. Chest-piece in brass, chrome-plated
- STETHOSCOPE, Dual Adult / Paediatric  
High sensitivity combination chest piece with no chill ring and translucent mica diaphragm.  
01 Chest-piece in brass, chrome-plated.  
02 Chest-piece in aluminium.
- STETHOSCOPE, Cardiology  
Light-weight aluminium combination chest piece with extra deep bell for low frequency response and non-chill bell ring for patient comfort



**Item Name:** Sphygmomanometer, Mercurial

**Item Code:** D4s 19.002

- Traditional desk mercurial Sphygmomanometer with mercury locking device, Range 0-300mmHg, packed in light weight metal case. Supplied with adult Velcro cuff and blood pressure bulb.



**Item Name:** Diagnostic Set

**Item Code:** D4s 19.005

- Diagnostic Set complete with, Ophthalmoscope with and without Aperture, Otoscope with 3 speculae, Nasal Speculum, Bent Arm Illuminator, Tongue Depressor, Laryngeal Mirror size 3 and 4, Holder for Disposable tongue depressors, Complete in presentation box. Metal handle accommodates 2C size battery.



**Item Name:** Foetal Stethoscope

**Item Code:** D4s 19.003

- Available in wood, Plastic, Aluminium

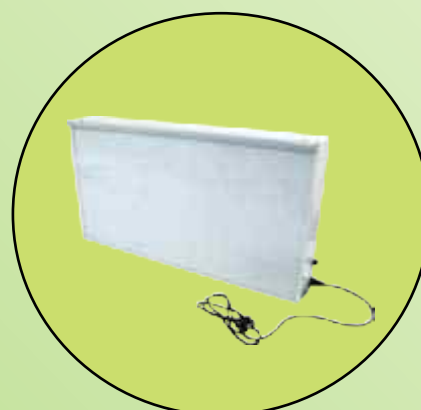

**Item Name:** X-Ray Viewer

**Item Code:** D4s 19.006

- X-Ray Viewer, Fluorescent Tubes, Epoxy steel Framework Single Film/ Double Film

## DIAGNOSTOC EQUIPMENT



**Item Name:** Height Measuring Scales with weighing scales

**Item Code:** D4s 19.007

- Can measure and weight and height.  
Maximum weight: 150 kilos.  
Maximum height: 200 cm.



**Item Name:** weighing scales

**Item Code:** D4s 19.008

- Can measure and weight.  
Maximum weight: 150 kg x .5Kg



**Item Name:** Baby weighing scales With Trousers

**Item Code:** D4s 19.009

- Supplied with Two SS Suspension hooks and one Trouser.
- Capacity 25Kg x 100gms



**Item Name:** Baby Balance

**Item Code:** D4s 19.010

- Sliding Weight double beam balance.
- Epoxy Power Coated finish.
- Capacity 16Kg x 10gms

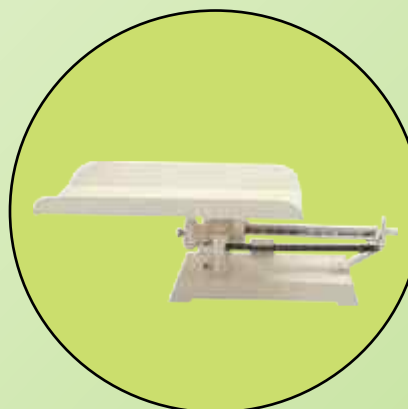

**Item Name:** Baby Balance

**Item Code:** D4s 19.011

- Sliding Weight double beam balance.
- Epoxy Power Coated finish.
- Capacity 16Kg x 10gms



**Item Name:** Baby Scale

**Item Code:** D4s 19.012

- It consists of a dial scale housed in a plastic body on which a metal platform (490 x 285 mm) is slid on. The dial reading can be set to zero by rotating the zero adjuster knob.
- A measuring scale 450mm is affixed to one of the sides of the two raised ends of the platform for measuring the baby's height.

Range	Division
A	0-10 kg x 50g
B	0-16 kg x 50g
C	0-20 kg x 100g

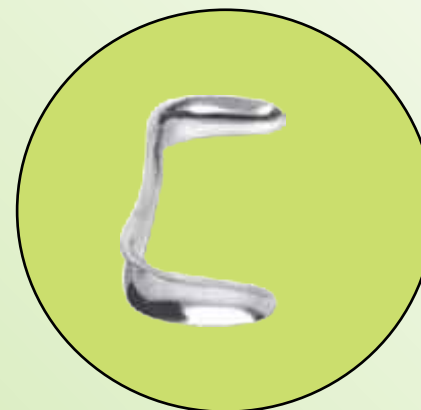

**Item Name:** Vaginal Speculum, Duck Bill

**Item Code:** D4s 19.015

01	Small
02	Medium
03	Large



**Item Name:** Angle Poised Lamp

**Item Code:** D4s 19.013

- Approx. : 100 cm. high, floor stand type with cast iron base. Arm : approx. 75 cm. articulated, spring loaded arm.
- Voltage : 110/220V.
- Bulb : max. 75W incandescent bulb Shade : Approx. 19cm dia., light opening, free cord : approx. 3 meter



**Item Name:** Vaginal Speculum, Cusco

**Item Code:** D4s 19.016

01	Small
02	Medium
03	Large

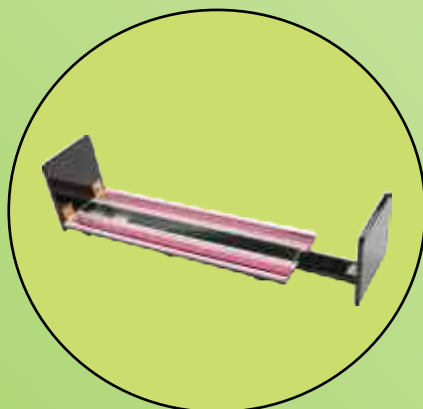

**Item Name:** Infanto Meter

**Item Code:** D4s 19.014

- Sleek broad base with one sliding adjustable side, dual scale for direct reading in cms / inches, folding slides for easy storage.

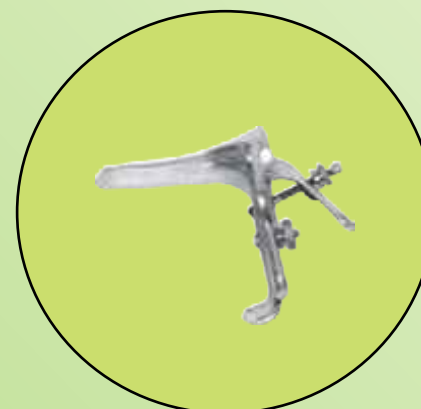

**Item Name:** Vaginal Speculum, Grave

**Item Code:** D4s 19.017

01	Small
02	Medium
03	Large



**Kiran TECHNO SERVICES**  
PRIVATE LIMITED



**Delhi :** A - 39, Street No.5, Chander Industrial Estate, I.P Extension, Delhi - 110 092

**Gujarat :** 308/4, GIDC Estate, Makarpura Industrial Estate, Baroda – 390 010,

**Andhra Pradesh :** No. 6-5-351/5, Astal Heights, Road No. 1, Banjara Hills, Hyderabad – 500 034

**Tamil Nadu :** No.33-B4, Sidco Industrial Estate Phase - II, Sundarapuram, Coimbatore - 641 021

**Kerala :** 333/9, Para Road, Near NIDA, Kanjikode, Palakkad - 678 621

**Helpline :** +91 9751725000, +91 9751625000, + 91 9751425000, + 91 9751215000, + 91 9751245000

**Email :** kirangroup108@gmail.com, kiranindia108@gmail.com, kiranbiz108@gmail.com

**Website :** www.kirangroupofcompanies.com, www.kiran.biz, www.kiranshop.in, www.kiranindia.in,  
www.kiransurgicalsystems.com, www.kiranmedicareequipments.com, www.kiranpump.com,  
www.kiransolarsystems.com, www.kiranled.com, www.kiranincinerationsystems.com  
www.kiranequipments.com, www.kirancompressors.com, www.kiranappliances.com  
www.kiranairventilators.com, www.kiranfrpproducts.com, www.kiranpebsystems.com,  
www.kiranpanels.com, www.kiranfabssystems.com